

## Introduction

These tests were carried out by the Orluna Innovations Team using calibrated Goniophotometric equipment. We have strict standards regarding the performance and testing of luminaires, and every luminaire has been tested in the environment that we recommend.

## Standards

We always ensure the following:

- Every luminaire is tested at its recommended case temperature of 85°C – a cold test (25°C) isn't an accurate test;
- Every luminaire uses production components and is presented as an average of product performance rather than a “best case”;
- When testing for the light output ratio of a bezel, the same engine is used between bezel tests to ensure a true comparison;
- We adhere to all available standards including CIE 1931, IESNA TM-30-15, CIE 177:2007, SPIE5941.

## Equipment & Tolerances

Orluna testing is carried out using a Viso Lightspion calibrated by Viso. In-depth testing by DTU (The Danish University of Photonics) has shown that the maximum tolerance of this test equipment is 2.18%.

## Environment

Every one of our test luminaires is pre-heated until light output is stable (less than a 2% drop over 15 minutes) to ensure that performance in testing is fully indicative of performance in reality. The Viso Lightspion monitors light level fluctuation over time to ensure that a luminaire has reached a stable point before continuing. It also eliminates ambient light to ensure that other light sources do not impact the testing, and we ensure that the environment does not contain any source of natural light.

## Disclaimer

This information is provided to be informative and to give the fullest view of our luminaires and testing. As with all electronic devices, some variation may occur in delivered products. The LEDs we use have a maximum light output tolerance of 7% (+/- 3.5%) and the environment will always play a role in performance. Heat in particular has an impact on lumen output, CCT and colour rendering, and a variation from our test conditions (such as extreme cold or extreme heat) will provide different results. The results found here should be used to indicate the expected performance of the product but should not be relied upon as a warranty of performance or to indicate the applicability of similar products. If you have any questions about performance of your luminaires we will always look to help you and will replace any products that aren't performing in line with our extensive warranty, so please get in touch.

# ORLUNA<sup>®</sup>

Light efficiency:

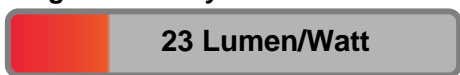

Light quality:



Color temperature:



Output: 100 lm

Peak: 243 cd

Power: 4.4 W

PF: 0.57

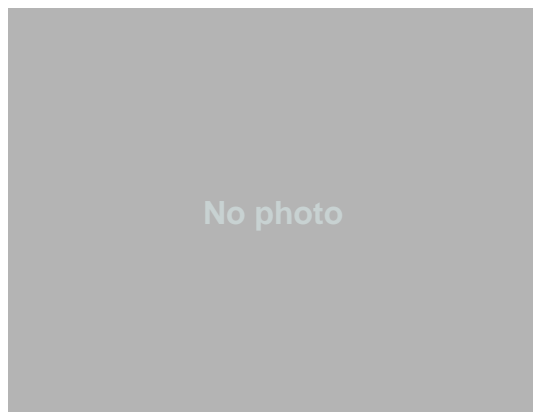

Beam angle

## 35.6°

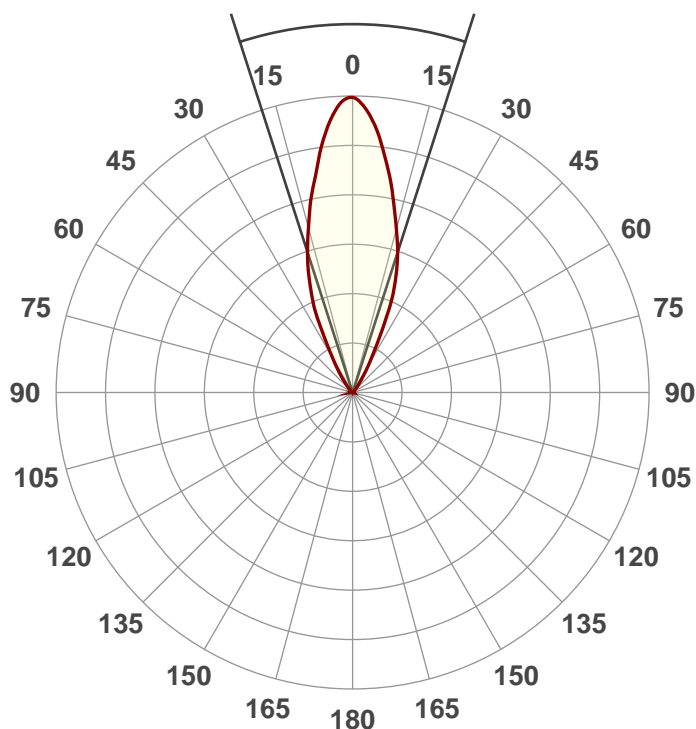

Product Name:

**Roc 100 2700K + 48°**

Item Number:

Date and Time:

**10/08/2017 10:39:56**

Description:



CIE 1931  
x: 0.453  
y: 0.412

Spectra

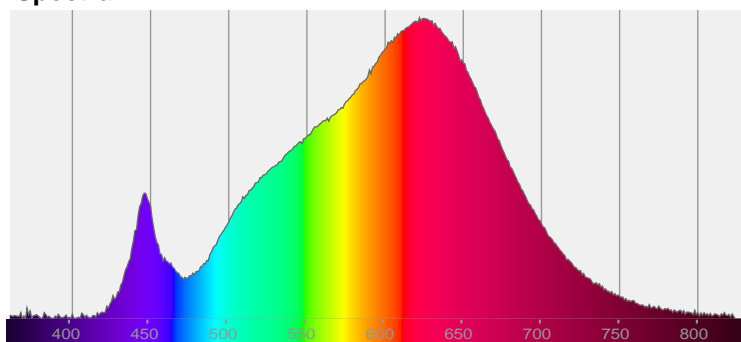

Power

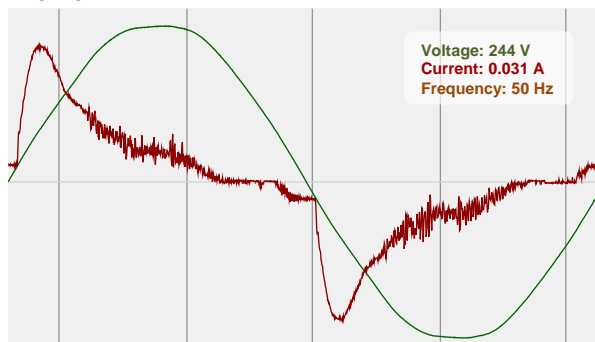

[www.orlduna.com](http://www.orlduna.com)

Orluna<sup>®</sup> is a registered trademark of Orluna LED Technologies Ltd

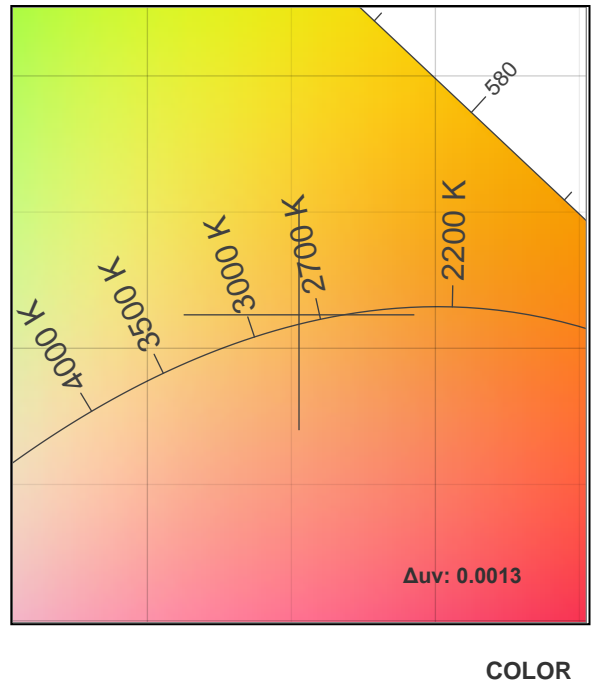
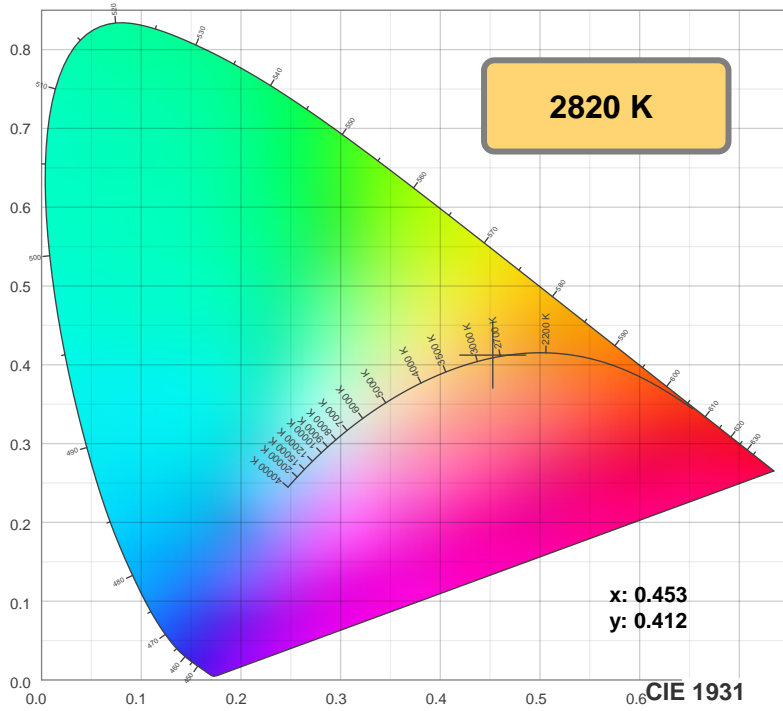

**TM30: 90.1**

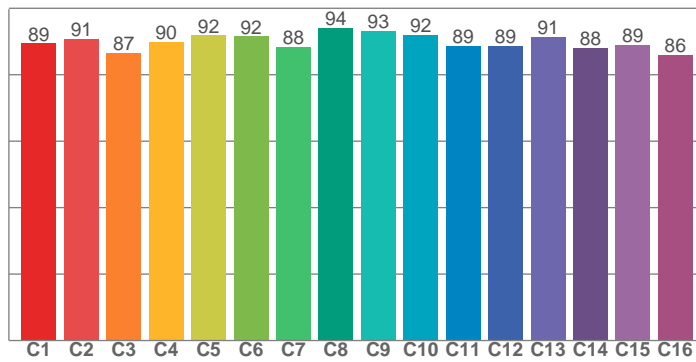

**CRI: 91.7 (R1-R8)**

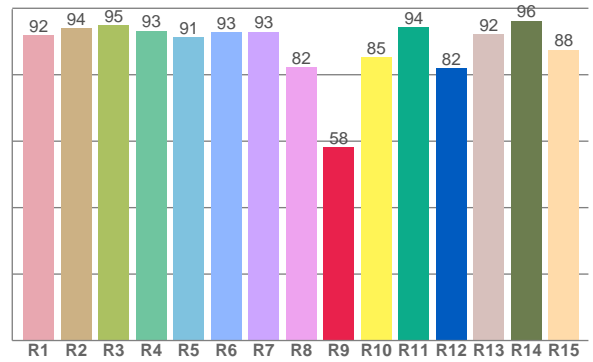

**CRI R values, only R1-R8 are used to calculate final CRI value**

R1	R2	R3	R4	R5	R6	R7	R8	R9	R10	R11	R12	R13	R14	R15
92.0	94.0	94.8	93.3	91.3	92.9	93.0	82.3	58.1	85.2	94.3	82.0	92.2	96.3	87.5

**TM30 C values, 16 binned values out of total of 99 C values**

C1	C2	C3	C4	C5	C6	C7	C8	C9	C10	C11	C12	C13	C14	C15	C16
89.5	90.8	86.6	90.0	91.9	91.6	88.5	94.2	93.2	92.0	88.6	88.6	91.5	88.1	89.0	86.1

**CQS Q values**

Q1	Q2	Q3	Q4	Q5	Q6	Q7	Q8	Q9	Q10	Q11	Q12	Q13	Q14	Q15
86.3	96.4	88.9	89.7	89.8	88.0	89.5	92.8	96.8	92.5	92.6	92.6	92.4	85.7	85.8

**CQS: 89.9**

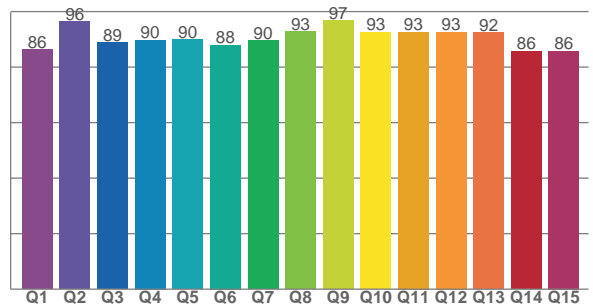

### Color parameters

Colour Temperature	Colour Rendering Index	Red Component	Colour Fidelity	Colour Gamut	Colour Quality Scale	Colour Coordinate CIE 1931	Colour Coordinate CIE 1931	Colour Coordinate	Colour Coordinate	Colour Deviation from Black Body
CCT	CRI	CRI R9	TM30 Rf	TM30 Rg	CQS	x	y	u	v	Δuv
2820 K	91.7	58.1	90.1	100.9	89.9	0.453	0.412	0.257	0.351	0.0013

**Rf 90.1**  
Fidelity Index Rf

**Rg 100.9**  
Gamut Index Rg

Hue Bin	R <sub>f</sub>	Graphic Shifts (%)	
		Chroma	Hue
1	89	-5%	-2%
2	91	-4%	3%
3	87	-1%	6%
4	90	2%	5%
5	92	4%	4%
6	92	5%	0%
7	88	2%	-6%
8	94	0%	-3%
9	93	-3%	-2%
10	92	-4%	2%
11	89	-2%	7%
12	89	4%	3%
13	91	4%	-3%
14	88	5%	-7%
15	89	1%	-6%
16	86	-2%	-10%

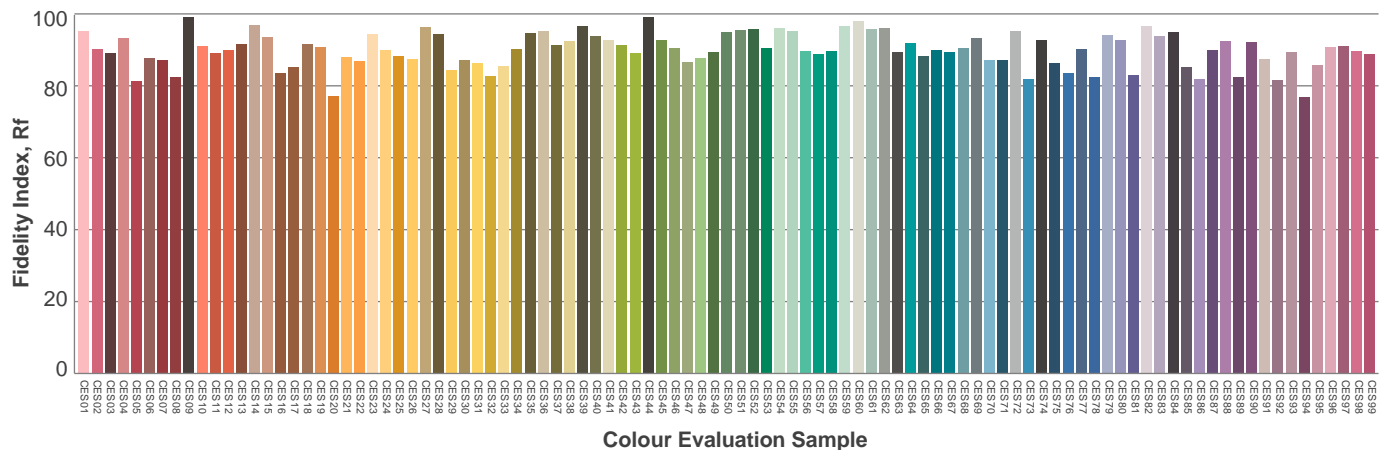
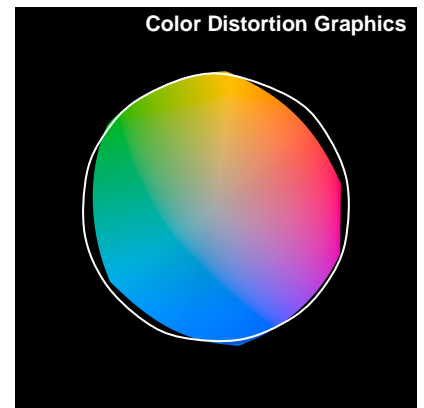
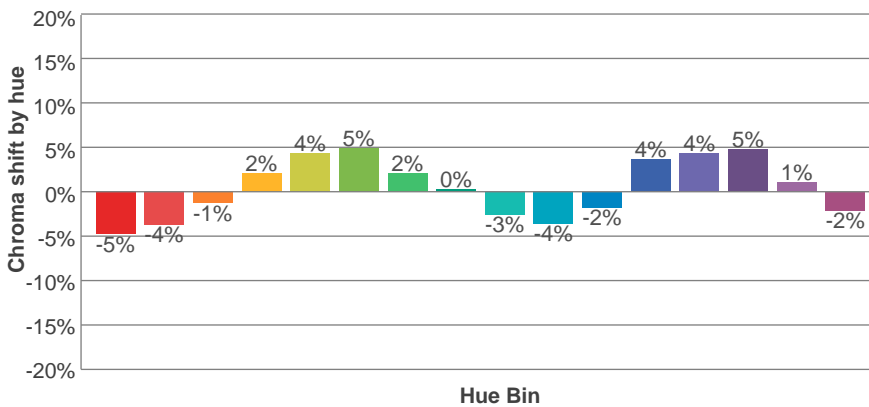
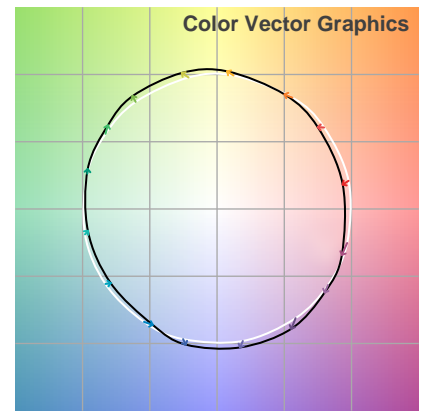
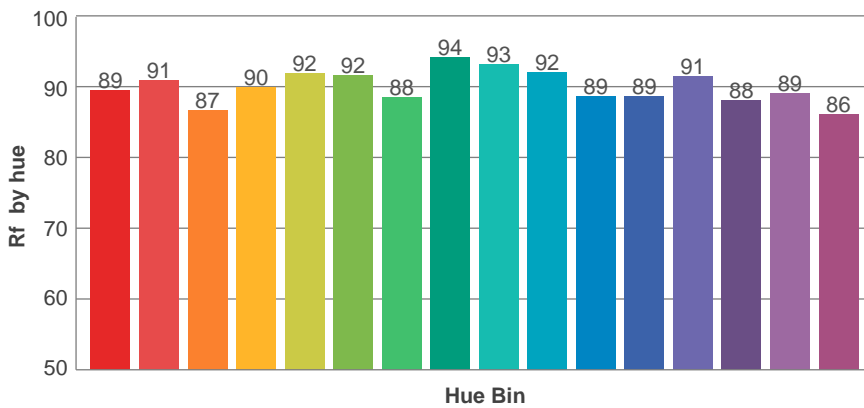
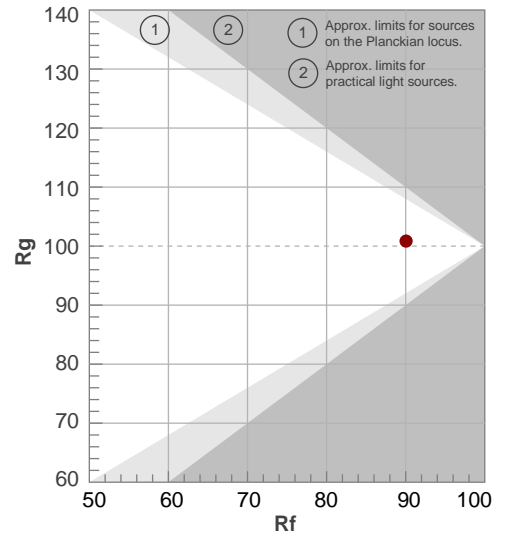

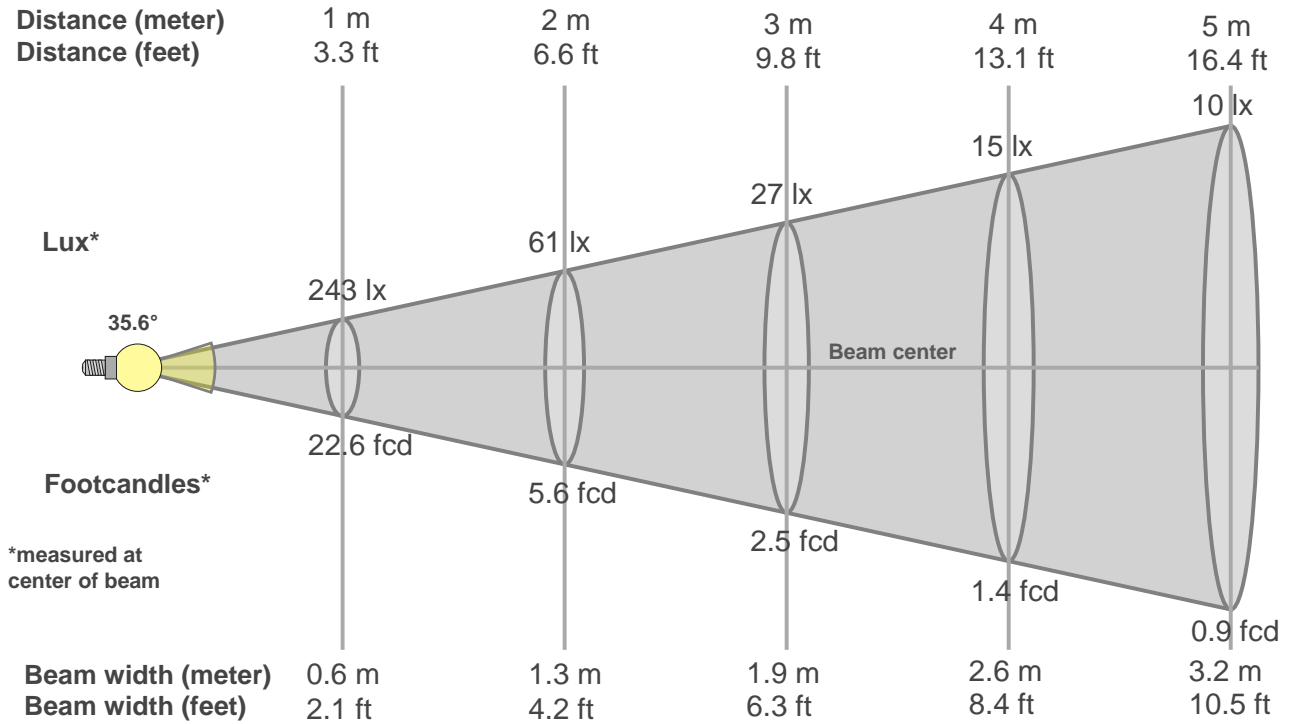

### Beam Intensities from 1-20m

1m	2m	3m	4m	5m	6m	7m	8m	9m	10m	11m	12m	13m	14m	15m	16m	17m	18m	19m	20m
3.3ft	6.6ft	9.8ft	13.1ft	16.4ft	19.7ft	23ft	26.2ft	29.5ft	32.8ft	36.1ft	39.4ft	42.7ft	45.9ft	49.2ft	52.5ft	55.8ft	59.1ft	62.3ft	65.6ft
243lx	61lx	27lx	15lx	10lx	7lx	5lx	4lx	3lx	2lx	2lx	2lx	1lx	1lx	1lx	1lx	1lx	1lx	1lx	1lx
22.6fcd	5.6fcd	2.5fcd	1.4fcd	0.9fcd	0.6fcd	0.5fcd	0.4fcd	0.3fcd	0.2fcd	0.2fcd	0.2fcd	0.1fcd	0.1fcd	0.1fcd	0.1fcd	0.1fcd	0.1fcd	0.1fcd	0.1fcd

### Intensities in 0° C-Plane

0°	2°	4°	6°	8°	10°	12°	14°	16°	18°	20°	22°	24°	26°	28°	30°	32°	34°	36°	38°
243	240	229	215	198	179	165	149	134	120	107	92	79	62	45	33	26	19	14	10
100%	99%	94%	88%	81%	74%	68%	61%	55%	50%	44%	38%	32%	25%	19%	14%	11%	8%	6%	4%

### Intensities in 90° C-Plane

0°	2°	4°	6°	8°	10°	12°	14°	16°	18°	20°	22°	24°	26°	28°	30°	32°	34°	36°	38°
243	240	229	215	198	179	165	149	134	120	107	92	79	62	45	33	26	19	14	10
100%	99%	94%	88%	81%	74%	68%	61%	55%	50%	44%	38%	32%	25%	19%	14%	11%	8%	6%	4%

### Intensities in 180° C-Plane

0°	2°	4°	6°	8°	10°	12°	14°	16°	18°	20°	22°	24°	26°	28°	30°	32°	34°	36°	38°
243	237	226	212	195	179	162	147	133	120	106	90	71	51	36	27	19	13	9	6
100%	97%	93%	87%	80%	74%	67%	61%	55%	50%	44%	37%	29%	21%	15%	11%	8%	6%	4%	3%

### Intensities in 270° C-Plane

0°	2°	4°	6°	8°	10°	12°	14°	16°	18°	20°	22°	24°	26°	28°	30°	32°	34°	36°	38°
243	237	226	212	195	179	162	147	133	120	106	90	71	51	36	27	19	13	9	6
100%	97%	93%	87%	80%	74%	67%	61%	55%	50%	44%	37%	29%	21%	15%	11%	8%	6%	4%	3%

Beam Angle 50%	Field Angle 10%	Cut-off Angle 2.5%	Intensity Ratio in 120° Cone	Intensity Ratio in 90° Cone
35.6°	63°	79.6°	99.6%	98.7%

### Glare Evaluation According to UGR

p Ceiling	70	70	50	50	30	70	70	50	50	30	
p Walls	50	30	50	30	30	50	30	50	30	30	
p Floor	20	20	20	20	20	20	20	20	20	20	
Room size X Y	Viewing direction at right angles to lamp axis					Viewing direction parallel to lamp axis					
2H	2H	20.2	20.9	20.5	21.1	21.3	19.3	20.0	19.6	20.2	20.4
	3H	20.1	20.7	20.4	20.9	21.2	19.2	19.8	19.5	20.1	20.3
	4H	20.1	20.6	20.4	20.9	21.2	19.2	19.8	19.5	20.0	20.3
	6H	20.1	20.6	20.4	20.9	21.1	19.2	19.7	19.5	20.0	20.2
	8H	20.1	20.6	20.4	20.9	21.2	19.2	19.7	19.5	20.0	20.3
	12H	20.2	20.6	20.5	20.9	21.2	19.2	19.7	19.6	20.0	20.3
4H	2H	20.0	20.6	20.3	20.8	21.1	19.1	19.7	19.4	20.0	20.2
	3H	19.9	20.4	20.3	20.7	21.0	19.0	19.5	19.4	19.8	20.1
	4H	19.9	20.3	20.3	20.7	21.0	19.0	19.4	19.4	19.8	20.1
	6H	19.9	20.3	20.3	20.6	21.0	19.0	19.4	19.4	19.7	20.1
	8H	20.0	20.3	20.4	20.7	21.1	19.1	19.4	19.5	19.8	20.2
	12H	20.2	20.4	20.6	20.8	21.2	19.2	19.5	19.6	19.9	20.3
8H	4H	19.8	20.1	20.2	20.5	20.9	18.9	19.2	19.4	19.6	20.0
	6H	19.9	20.1	20.3	20.5	21.0	19.0	19.2	19.4	19.6	20.1
	8H	20.0	20.2	20.5	20.6	21.1	19.1	19.3	19.5	19.7	20.2
	12H	20.3	20.4	20.8	20.9	21.4	19.3	19.5	19.8	19.9	20.4
12H	4H	19.8	20.1	20.2	20.5	20.9	18.9	19.2	19.3	19.6	20.0
	6H	19.9	20.1	20.3	20.5	21.0	19.0	19.1	19.4	19.6	20.1
	8H	20.0	20.2	20.5	20.6	21.1	19.1	19.2	19.6	19.7	20.2
Variation of the observer position for the luminaire distance S											
S = 1.0H	+4.9 / -5.4					+5.0 / -5.8					
S = 1.5H	+7.7 / -6.0					+7.7 / -6.5					
S = 2.0H	+9.7 / -6.7					+9.7 / -7.2					
Standard table	BK01					BK00					
Correction summand	2.1					1.1					
Corrected glare indices referring to 100lm total luminous flux											