

Introduction

These tests were carried out by the Orluna Innovations Team using calibrated Goniophotometric equipment. We have strict standards regarding the performance and testing of luminaires, and every luminaire has been tested in the environment that we recommend.

Standards

We always ensure the following:

- Every luminaire is tested at its recommended case temperature of 85°C - a cold test (25°C) isn't an accurate test;
- Every luminaire uses production components and is presented as an average of product performance rather than a "best case";
- When testing for the light output ratio of a bezel, the same engine is used between bezel tests to ensure a true comparison;
- We adhere to all available standards including CIE 1931, IESNA TM-30-15, CIE 177:2007, SPIE5941.

Equipment & Tolerances

Orluna testing is carried out using a Viso Lightspion calibrated by Viso. In-depth testing by DTU (The Danish University of Photonics) has shown that the maximum tolerance of this test equipment is 2.18%.

Environment

Every one of our test luminaires is pre-heated until light output is stable (less than a 2% drop over 15 minutes) to ensure that performance in testing is fully indicative of performance in reality. The Viso Lightspion monitors light level fluctuation over time to ensure that a luminaire has reached a stable point before continuing. It also eliminates ambient light to ensure that other light sources do not impact the testing, and we ensure that the environment does not contain any source of natural light.

Disclaimer

This information is provided to be informative and to give the fullest view of our luminaires and testing. As with all electronic devices, some variation may occur in delivered products. The LEDs we use have a maximum light output tolerance of 7% (+/- 3.5%) and the environment will always play a role in performance. Heat in particular has an impact on lumen output, CCT and colour rendering, and a variation from our test conditions (such as extreme cold or extreme heat) will provide different results. The results found here should be used to indicate the expected performance of the product but should not be relied upon as a warranty of performance or to indicate the applicability of similar products. If you have any questions about performance of your luminaires we will always look to help you and will replace any products that aren't performing in line with our extensive warranty, so please get in touch.

Light efficiency:

Infinity Lumen/Watt

Light quality:

CRI: 91.6

Color temperature:

2711 K

Output: 244 lm

Peak: 1292 cd

Power: - W

PF: n/a

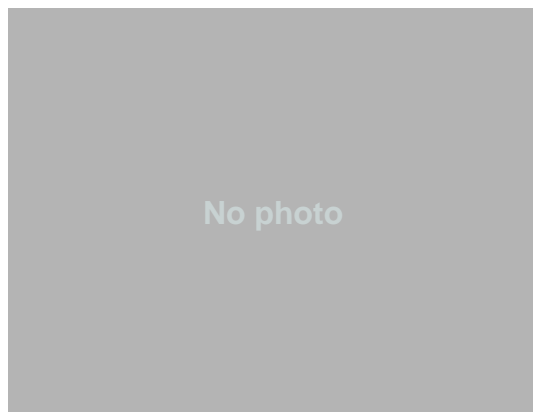

Beam angle

18.2°

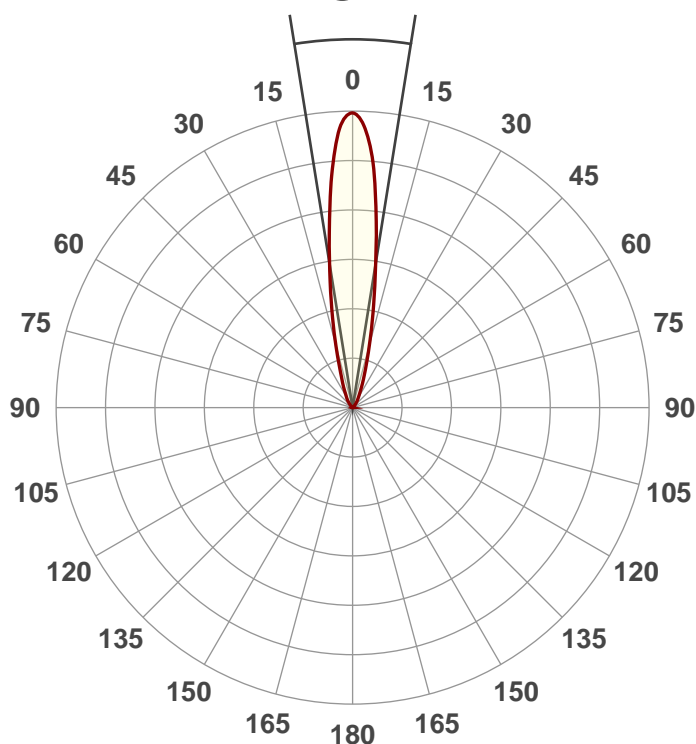

Product Name:

Arc 200 2700K + 10Å°

Item Number:

Date and Time:

17/08/2017 15:47:43

Description:



CIE 1931
x: 0.462
y: 0.415

Spectra

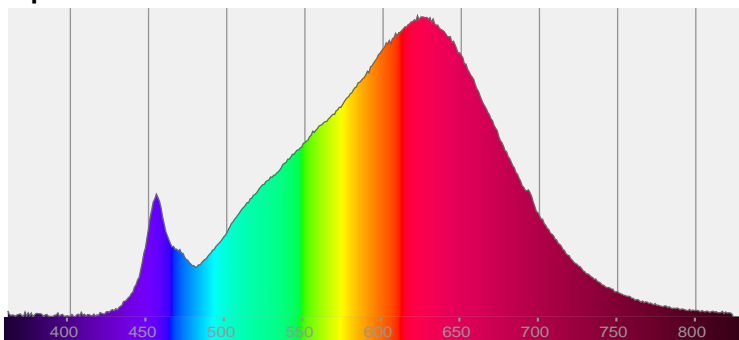

Power

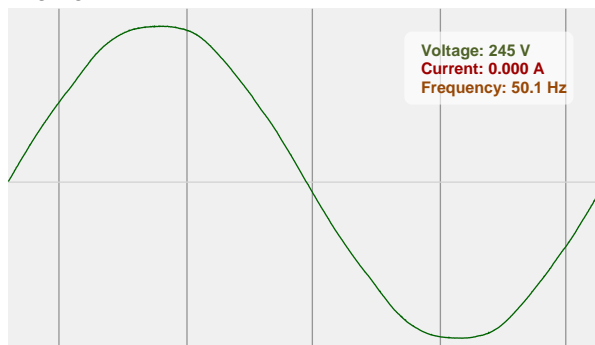

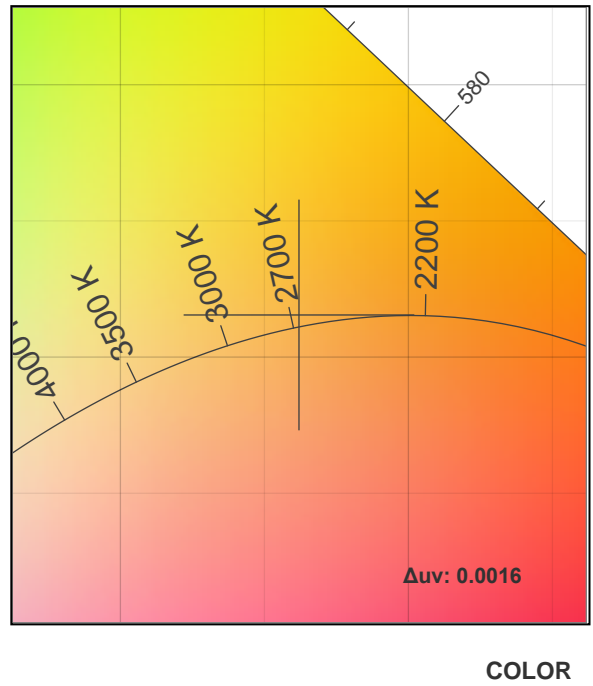
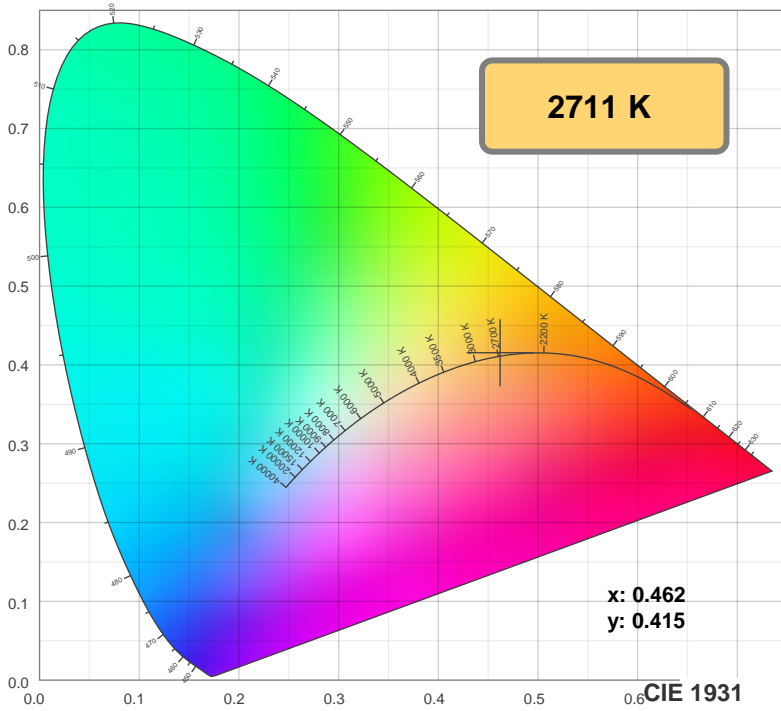

TM30: 89.5

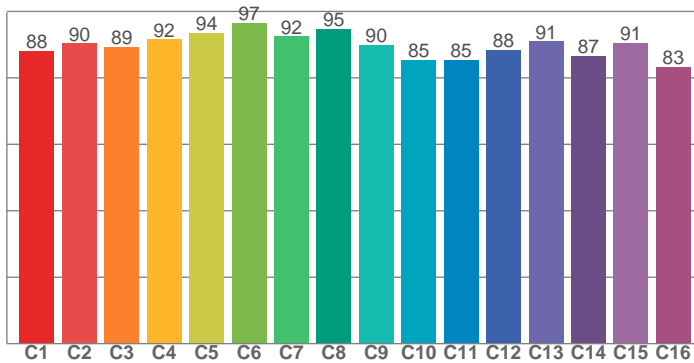

CRI: 91.6 (R1-R8)

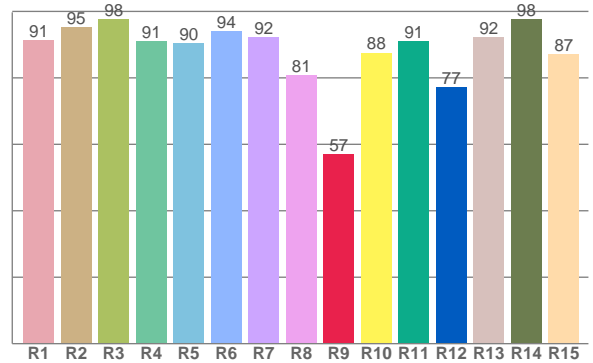

CRI R values, only R1-R8 are used to calculate final CRI value

R1	R2	R3	R4	R5	R6	R7	R8	R9	R10	R11	R12	R13	R14	R15
91.3	95.2	97.5	91.1	90.4	94.1	92.2	80.7	57.0	87.5	91.1	77.3	92.2	97.7	87.1

TM30 C values, 16 binned values out of total of 99 C values

C1	C2	C3	C4	C5	C6	C7	C8	C9	C10	C11	C12	C13	C14	C15	C16
88.1	90.4	89.3	91.6	93.5	96.5	92.5	94.7	90.0	85.4	85.4	88.5	91.0	86.6	90.5	83.3

CQS Q values

Q1	Q2	Q3	Q4	Q5	Q6	Q7	Q8	Q9	Q10	Q11	Q12	Q13	Q14	Q15
87.6	94.7	88.3	86.3	88.7	89.9	90.8	92.7	96.7	93.7	92.2	91.9	91.6	85.7	86.6

CQS: 89.8

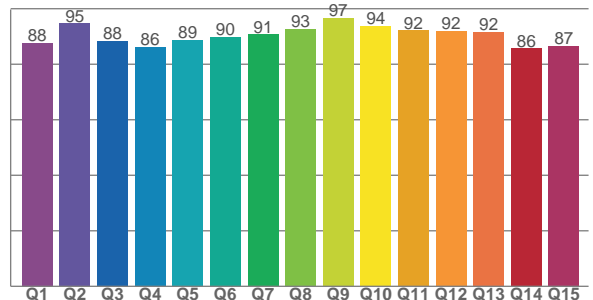

Color parameters

Colour Temperature	Colour Rendering Index	Red Component	Colour Fidelity	Colour Gamut	Colour Quality Scale	Colour Coordinate CIE 1931	Colour Coordinate CIE 1931	Colour Coordinate	Colour Coordinate	Colour Deviation from Black Body
CCT	CRI	CRI R9	TM30 Rf	TM30 Rg	CQS	x	y	u	v	Δuv
2711 K	91.6	57.0	89.5	97.3	89.8	0.462	0.415	0.262	0.353	0.0016

Rf 89.5
Fidelity Index Rf

Rg 97.3
Gamut Index Rg

Hue Bin	R _f	Graphic Shifts (%)	
		Chroma	Hue
1	88	-5%	1%
2	90	-4%	2%
3	89	-2%	4%
4	92	-3%	1%
5	94	-2%	2%
6	97	0%	1%
7	92	-4%	0%
8	95	-3%	1%
9	90	-3%	4%
10	85	-1%	9%
11	85	2%	10%
12	88	5%	1%
13	91	2%	-5%
14	87	4%	-9%
15	91	-3%	-3%
16	83	-3%	-11%

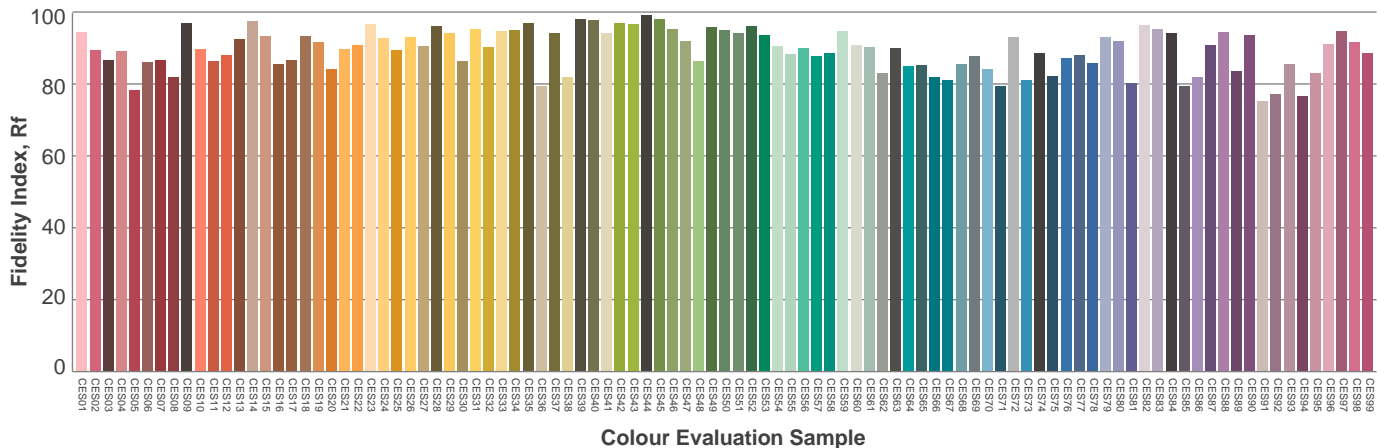
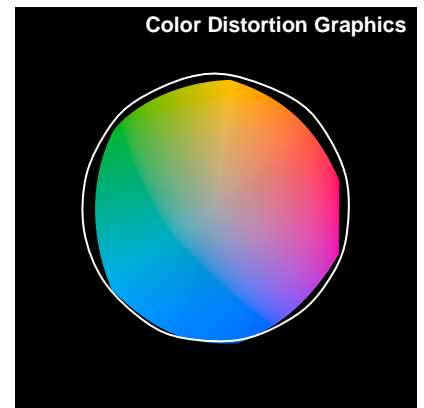
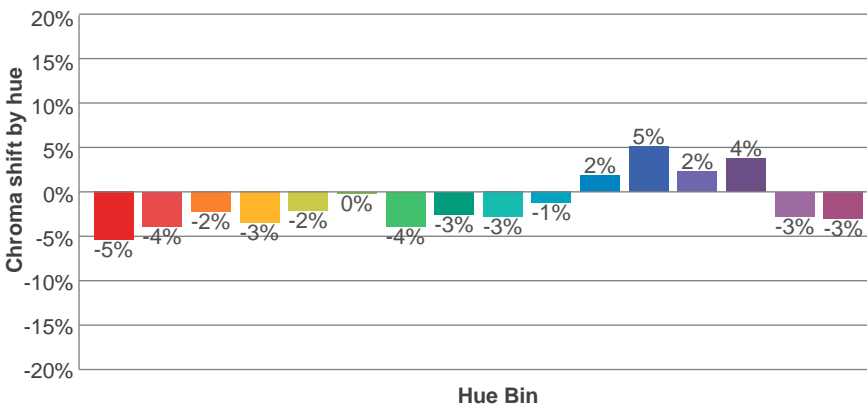
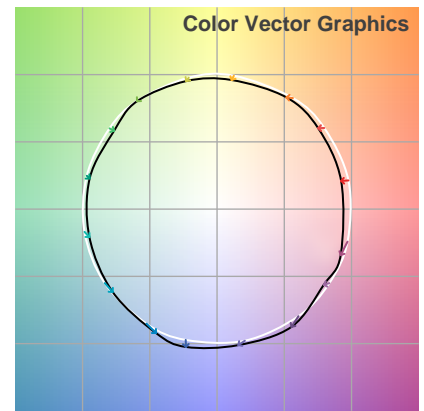
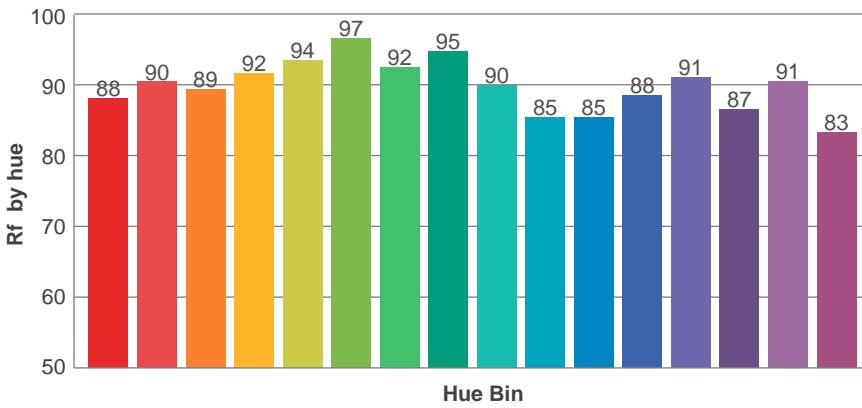
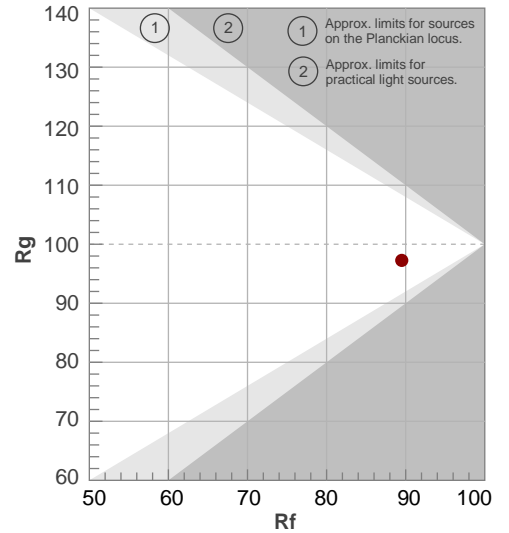

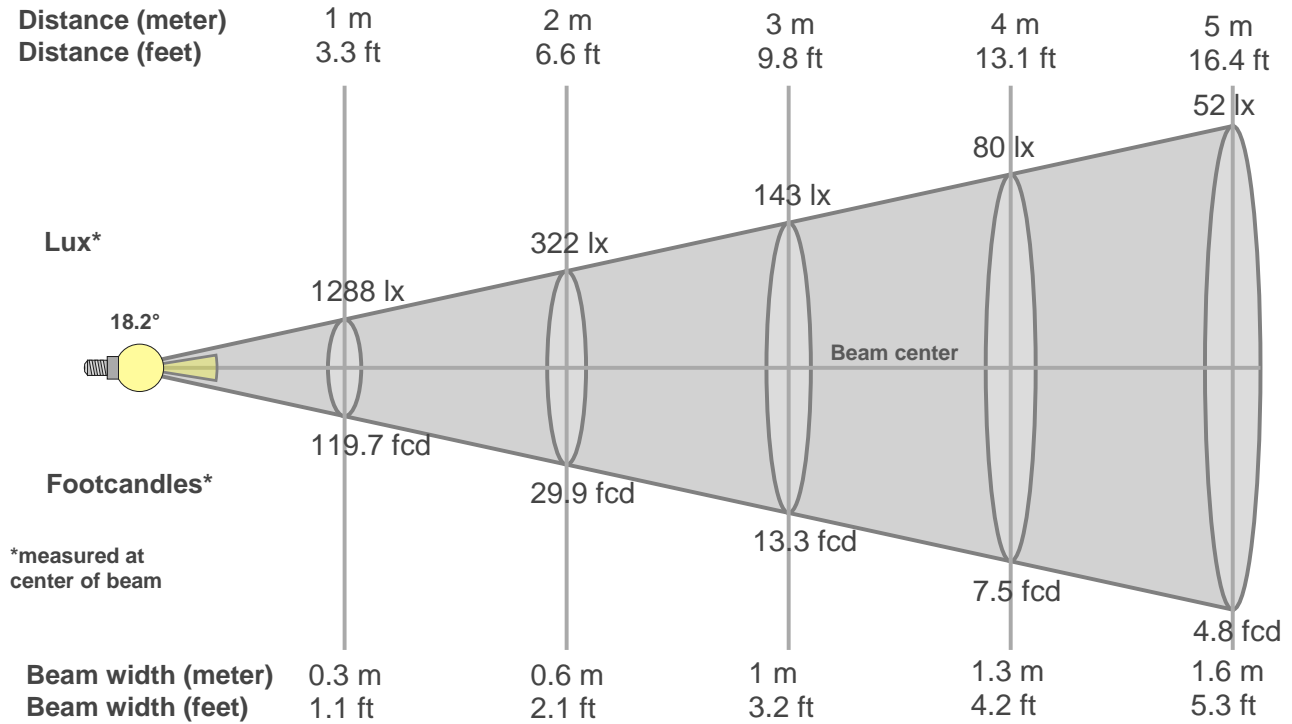

Beam Intensities from 1-20m

1m	2m	3m	4m	5m	6m	7m	8m	9m	10m	11m	12m	13m	14m	15m	16m	17m	18m	19m	20m
3.3ft	6.6ft	9.8ft	13.1ft	16.4ft	19.7ft	23ft	26.2ft	29.5ft	32.8ft	36.1ft	39.4ft	42.7ft	45.9ft	49.2ft	52.5ft	55.8ft	59.1ft	62.3ft	65.6ft
1288lx	322lx	143lx	80lx	52lx	36lx	26lx	20lx	16lx	13lx	11lx	9lx	8lx	7lx	6lx	5lx	4lx	4lx	4lx	3lx
119.7fcd	29.9fcd	13.3fcd	7.5fcd	4.8fcd	3.3fcd	2.4fcd	1.9fcd	1.5fcd	1.2fcd	1fcd	0.8fcd	0.7fcd	0.6fcd	0.5fcd	0.5fcd	0.4fcd	0.4fcd	0.3fcd	0.3fcd

Intensities in 0° C-Plane

0°	2°	4°	6°	8°	10°	12°	14°	16°	18°	20°	22°	24°	26°	28°	30°	32°	34°	36°	38°
1288	1243	1116	935	739	570	441	334	249	185	142	117	96	77	63	54	47	40	33	26
100%	97%	87%	73%	57%	44%	34%	26%	19%	14%	11%	9%	7%	6%	5%	4%	4%	3%	3%	2%

Intensities in 90° C-Plane

0°	2°	4°	6°	8°	10°	12°	14°	16°	18°	20°	22°	24°	26°	28°	30°	32°	34°	36°	38°
1288	1243	1116	935	739	570	441	334	249	185	142	117	96	77	63	54	47	40	33	26
100%	97%	87%	73%	57%	44%	34%	26%	19%	14%	11%	9%	7%	6%	5%	4%	4%	3%	3%	2%

Intensities in 180° C-Plane

0°	2°	4°	6°	8°	10°	12°	14°	16°	18°	20°	22°	24°	26°	28°	30°	32°	34°	36°	38°
1288	1244	1127	951	751	569	436	332	252	192	149	117	93	74	60	50	42	35	29	23
100%	97%	88%	74%	58%	44%	34%	26%	20%	15%	12%	9%	7%	6%	5%	4%	3%	3%	2%	2%

Intensities in 270° C-Plane

0°	2°	4°	6°	8°	10°	12°	14°	16°	18°	20°	22°	24°	26°	28°	30°	32°	34°	36°	38°
1288	1244	1127	951	751	569	436	332	252	192	149	117	93	74	60	50	42	35	29	23
100%	97%	88%	74%	58%	44%	34%	26%	20%	15%	12%	9%	7%	6%	5%	4%	3%	3%	2%	2%

Beam Angle 50%	Field Angle 10%	Cut-off Angle 2.5%	Intensity Ratio in 120° Cone	Intensity Ratio in 90° Cone
18.2°	42.3°	71.2°	97.5%	94.6%

Glare Evaluation According to UGR

p Ceiling	70	70	50	50	30	70	70	50	50	30	
p Walls	50	30	50	30	30	50	30	50	30	30	
p Floor	20	20	20	20	20	20	20	20	20	20	
Room size X Y	Viewing direction at right angles to lamp axis					Viewing direction parallel to lamp axis					
2H	2H	24.2	24.9	24.5	25.1	25.3	24.1	24.8	24.3	25.0	25.2
	3H	24.9	25.6	25.2	25.8	26.1	24.9	25.5	25.2	25.8	26.0
	4H	25.2	25.9	25.6	26.1	26.4	25.3	25.9	25.6	26.1	26.4
	6H	25.5	26.1	25.8	26.3	26.6	25.6	26.1	25.9	26.4	26.7
	8H	25.6	26.1	25.9	26.4	26.7	25.7	26.2	26.0	26.5	26.8
	12H	25.6	26.1	25.9	26.4	26.7	25.8	26.3	26.1	26.6	26.9
4H	2H	24.4	25.1	24.7	25.3	25.6	24.3	24.9	24.6	25.2	25.5
	3H	25.4	25.9	25.7	26.2	26.5	25.4	25.9	25.7	26.2	26.5
	4H	25.8	26.3	26.2	26.6	26.9	25.9	26.3	26.3	26.7	27.0
	6H	26.2	26.6	26.6	26.9	27.3	26.3	26.7	26.7	27.1	27.4
	8H	26.3	26.6	26.7	27.0	27.4	26.5	26.8	26.9	27.2	27.6
	12H	26.4	26.7	26.8	27.1	27.5	26.6	26.9	27.1	27.3	27.7
8H	4H	26.0	26.3	26.4	26.7	27.1	26.1	26.4	26.5	26.8	27.2
	6H	26.5	26.7	26.9	27.1	27.6	26.6	26.9	27.1	27.3	27.8
	8H	26.6	26.8	27.1	27.3	27.8	26.9	27.1	27.3	27.5	28.0
	12H	26.8	26.9	27.2	27.4	27.9	27.1	27.2	27.6	27.7	28.2
12H	4H	26.0	26.3	26.4	26.7	27.1	26.1	26.4	26.5	26.8	27.2
	6H	26.5	26.7	27.0	27.1	27.6	26.7	26.9	27.1	27.3	27.8
	8H	26.7	26.9	27.2	27.3	27.8	26.9	27.1	27.4	27.6	28.1
Variation of the observer position for the luminaire distance S											
S = 1.0H	+1.6 / -1.1					+1.4 / -0.9					
S = 1.5H	+3.4 / -1.2					+3.0 / -1.1					
S = 2.0H	+4.9 / -1.5					+4.5 / -1.3					
Standard table	BK03					BK04					
Correction summand	8.5					9.0					
Corrected glare indices referring to 244lm total luminous flux											