

Introduction

These tests were carried out by the Orluna Innovations Team using calibrated Goniophotometric equipment. We have strict standards regarding the performance and testing of luminaires, and every luminaire has been tested in the environment that we recommend.

Standards

We always ensure the following:

- Every luminaire is tested at its recommended case temperature of 85°C – a cold test (25°C) isn't an accurate test;
- Every luminaire uses production components and is presented as an average of product performance rather than a “best case”;
- When testing for the light output ratio of a bezel, the same engine is used between bezel tests to ensure a true comparison;
- We adhere to all available standards including CIE 1931, IESNA TM-30-15, CIE 177:2007, SPIE5941.

Equipment & Tolerances

Orluna testing is carried out using a Viso Lightspion calibrated by Viso. In-depth testing by DTU (The Danish University of Photonics) has shown that the maximum tolerance of this test equipment is 2.18%.

Environment

Every one of our test luminaires is pre-heated until light output is stable (less than a 2% drop over 15 minutes) to ensure that performance in testing is fully indicative of performance in reality. The Viso Lightspion monitors light level fluctuation over time to ensure that a luminaire has reached a stable point before continuing. It also eliminates ambient light to ensure that other light sources do not impact the testing, and we ensure that the environment does not contain any source of natural light.

Disclaimer

This information is provided to be informative and to give the fullest view of our luminaires and testing. As with all electronic devices, some variation may occur in delivered products. The LEDs we use have a maximum light output tolerance of 7% (+/- 3.5%) and the environment will always play a role in performance. Heat in particular has an impact on lumen output, CCT and colour rendering, and a variation from our test conditions (such as extreme cold or extreme heat) will provide different results. The results found here should be used to indicate the expected performance of the product but should not be relied upon as a warranty of performance or to indicate the applicability of similar products. If you have any questions about performance of your luminaires we will always look to help you and will replace any products that aren't performing in line with our extensive warranty, so please get in touch.

Light efficiency:

Infinity Lumen/Watt

Light quality:

CRI: 93.6

Color temperature:

3088 K

Output: 175 lm

Peak: 651 cd

Power: - W

PF: n/a

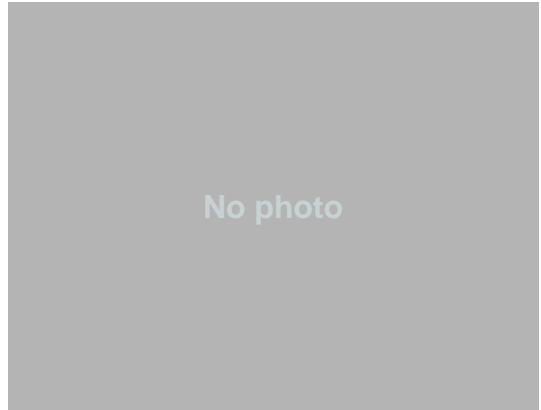

Beam angle

27°

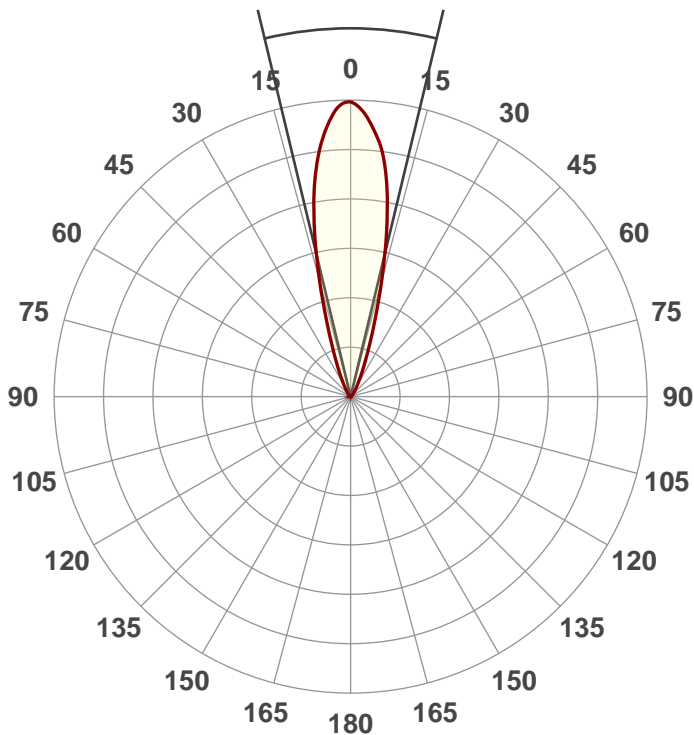

Product Name:

Arc 100 3000K + 28°

Item Number:

Date and Time:

18/08/2017 10:20:02

Description:



CIE 1931

x: 0.431

y: 0.402

Spectra

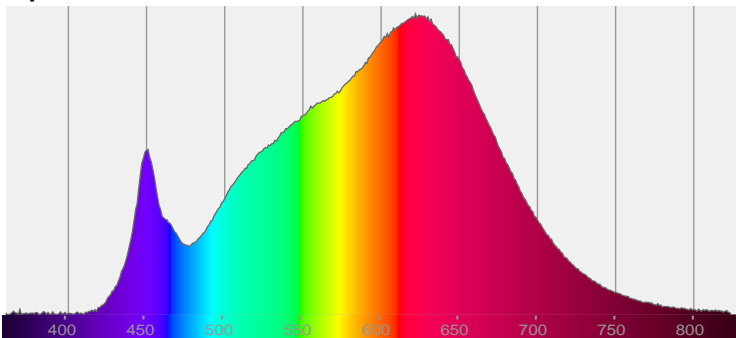

Power

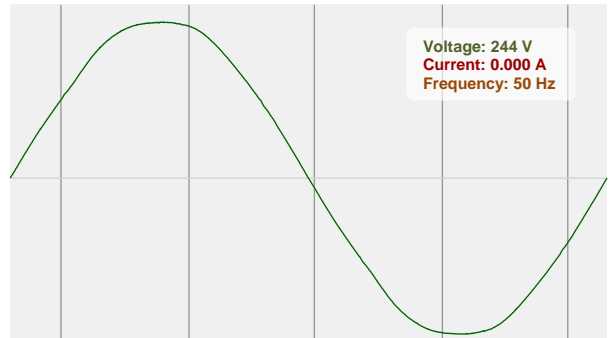

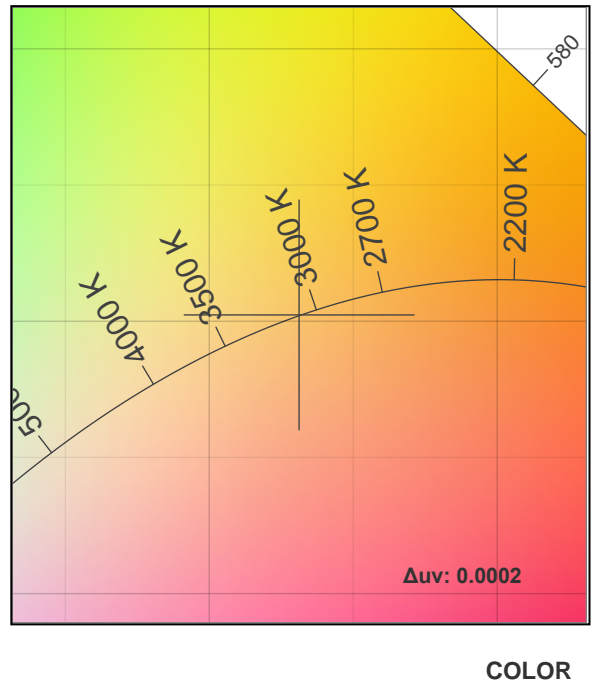
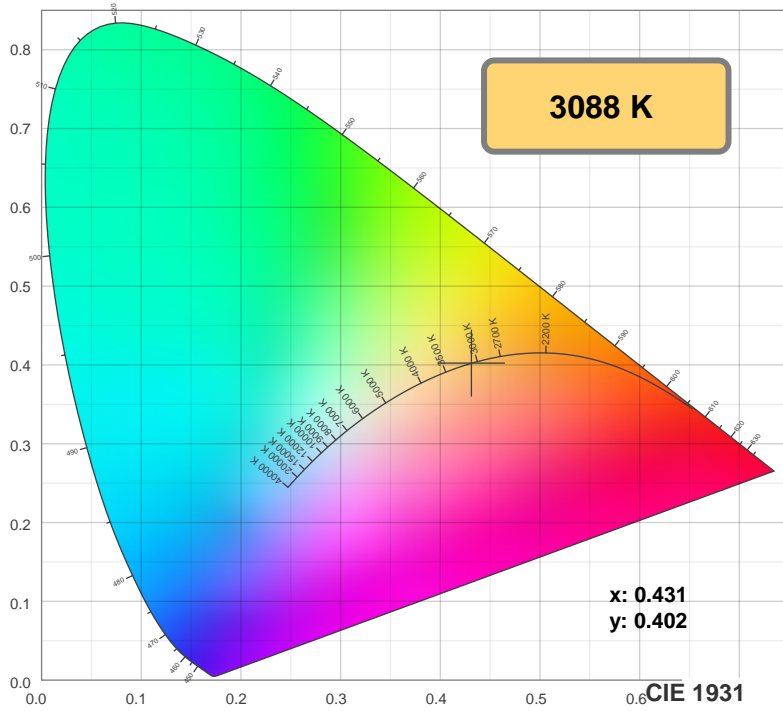

TM30: 91.7

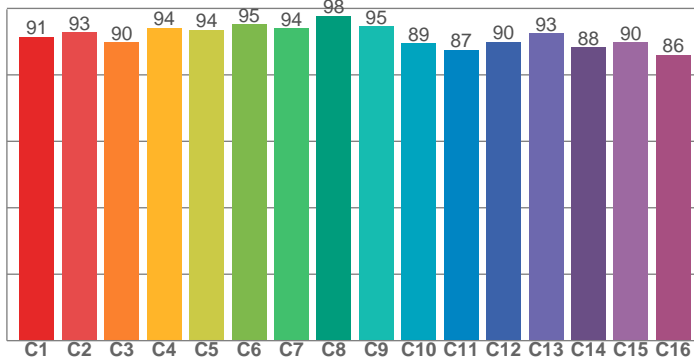

CRI: 93.6 (R1-R8)

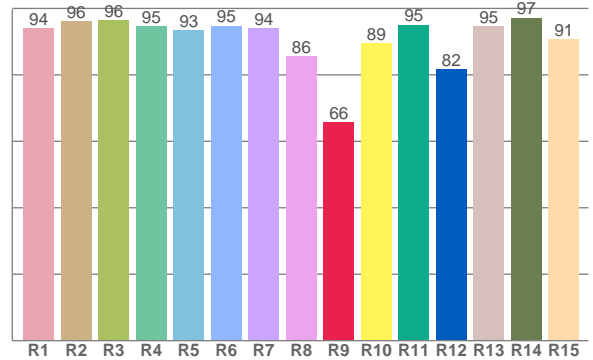

CRI R values, only R1-R8 are used to calculate final CRI value

R1	R2	R3	R4	R5	R6	R7	R8	R9	R10	R11	R12	R13	R14	R15
94.1	96.0	96.4	94.5	93.5	94.8	94.0	85.6	65.7	89.5	95.0	81.6	94.6	97.2	90.7

TM30 C values, 16 binned values out of total of 99 C values

C1	C2	C3	C4	C5	C6	C7	C8	C9	C10	C11	C12	C13	C14	C15	C16
91.4	92.8	89.8	94.1	93.5	95.2	94.0	97.8	94.7	89.4	87.4	90.0	92.5	88.3	89.7	86.0

CQS Q values

Q1	Q2	Q3	Q4	Q5	Q6	Q7	Q8	Q9	Q10	Q11	Q12	Q13	Q14	Q15
90.3	96.9	88.7	89.2	92.3	92.5	91.9	93.7	97.5	93.9	93.6	93.7	93.7	88.7	89.1

CQS: 91.8

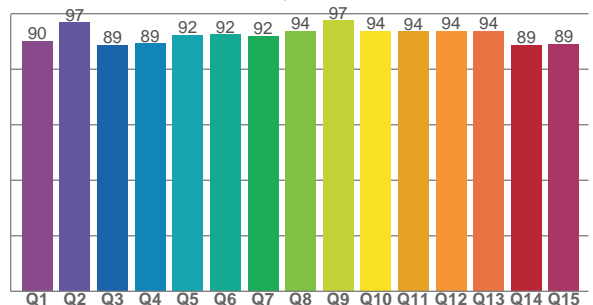

Color parameters

Colour Temperature	Colour Rendering Index	Red Component	Colour Fidelity	Colour Gamut	Colour Quality Scale	Colour Coordinate CIE 1931	Colour Coordinate CIE 1931	Colour Coordinate	Colour Coordinate	Colour Deviation from Black Body
CCT	CRI	CRI R9	TM30 Rf	TM30 Rg	CQS	x	y	u	v	Δuv
3088 K	93.6	65.7	91.7	100.2	91.8	0.431	0.402	0.248	0.347	0.0002

Rf 91.7
Fidelity Index Rf

Rg 100.2
Gamut Index Rg

Hue Bin	R _f	Graphic Shifts (%)	
		Chroma	Hue
1	91	-4%	-1%
2	93	-3%	2%
3	90	-1%	5%
4	94	0%	3%
5	94	0%	2%
6	95	2%	0%
7	94	-1%	-2%
8	98	-1%	-1%
9	95	-2%	2%
10	89	-2%	5%
11	87	1%	8%
12	90	5%	1%
13	93	3%	-3%
14	88	5%	-7%
15	90	0%	-6%
16	86	-1%	-10%

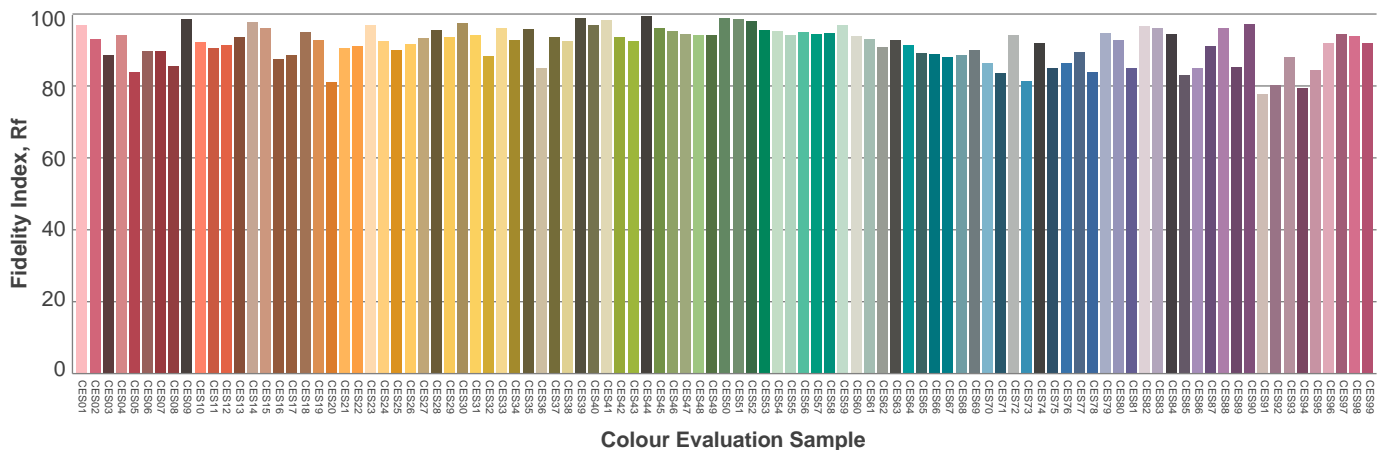
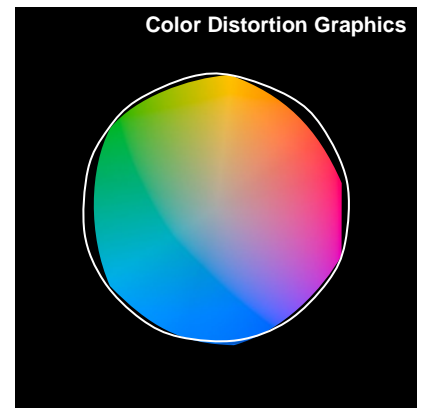
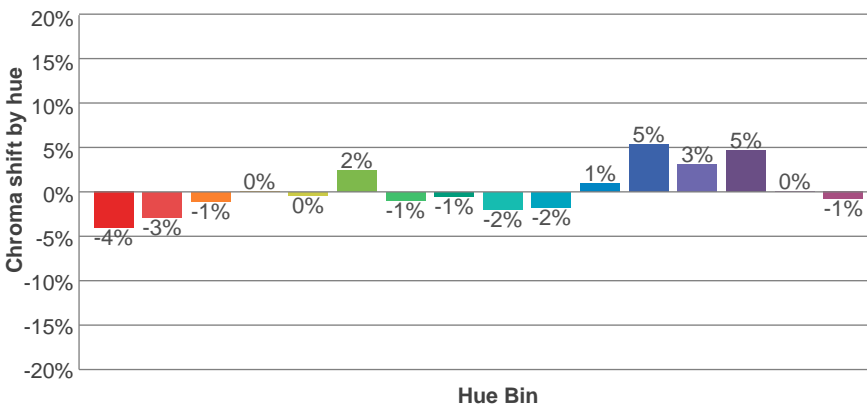
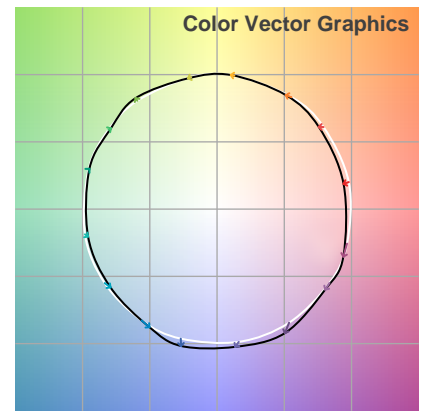
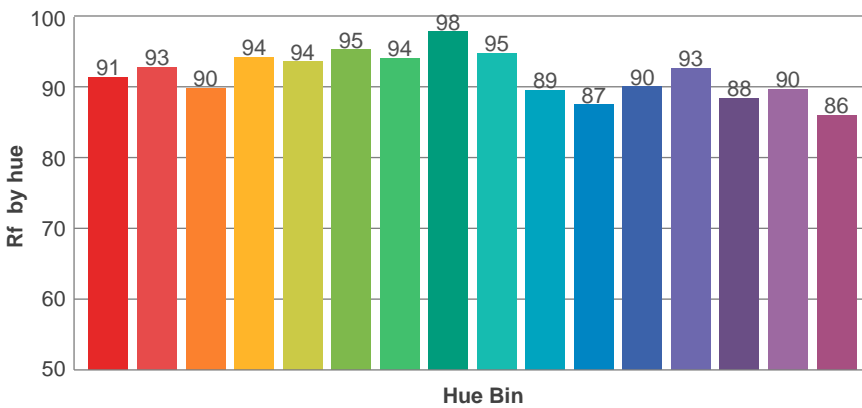
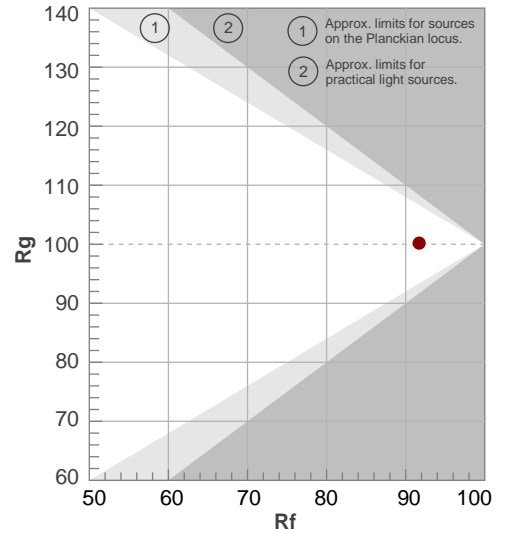

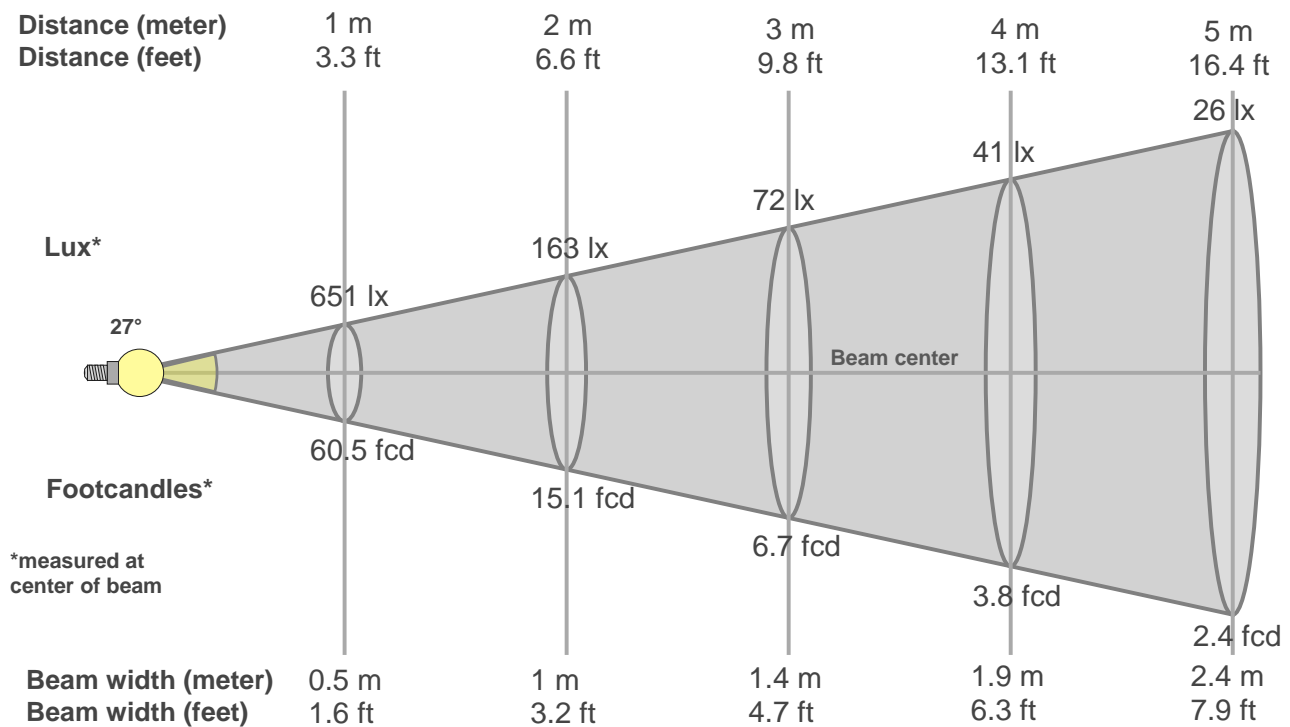

Beam Intensities from 1-20m

1m	2m	3m	4m	5m	6m	7m	8m	9m	10m	11m	12m	13m	14m	15m	16m	17m	18m	19m	20m
3.3ft	6.6ft	9.8ft	13.1ft	16.4ft	19.7ft	23ft	26.2ft	29.5ft	32.8ft	36.1ft	39.4ft	42.7ft	45.9ft	49.2ft	52.5ft	55.8ft	59.1ft	62.3ft	65.6ft
651lx	163lx	72lx	41lx	26lx	18lx	13lx	10lx	8lx	7lx	5lx	5lx	4lx	3lx	3lx	3lx	2lx	2lx	2lx	2lx
60.5fcd	15.1fcd	6.7fcd	3.8fcd	2.4fcd	1.7fcd	1.2fcd	0.9fcd	0.7fcd	0.6fcd	0.5fcd	0.4fcd	0.4fcd	0.3fcd	0.3fcd	0.2fcd	0.2fcd	0.2fcd	0.2fcd	0.2fcd

Intensities in 0° C-Plane

0°	2°	4°	6°	8°	10°	12°	14°	16°	18°	20°	22°	24°	26°	28°	30°	32°	34°	36°	38°
651	643	616	576	526	464	386	306	230	166	119	89	67	50	37	29	23	18	14	11
100%	99%	95%	88%	81%	71%	59%	47%	35%	26%	18%	14%	10%	8%	6%	4%	3%	3%	2%	2%

Intensities in 90° C-Plane

0°	2°	4°	6°	8°	10°	12°	14°	16°	18°	20°	22°	24°	26°	28°	30°	32°	34°	36°	38°
651	643	616	576	526	464	386	306	230	166	119	89	67	50	37	29	23	18	14	11
100%	99%	95%	88%	81%	71%	59%	47%	35%	26%	18%	14%	10%	8%	6%	4%	3%	3%	2%	2%

Intensities in 180° C-Plane

0°	2°	4°	6°	8°	10°	12°	14°	16°	18°	20°	22°	24°	26°	28°	30°	32°	34°	36°	38°
651	635	607	572	526	464	386	306	232	170	124	92	70	52	39	30	24	19	16	13
100%	98%	93%	88%	81%	71%	59%	47%	36%	26%	19%	14%	11%	8%	6%	5%	4%	3%	2%	2%

Intensities in 270° C-Plane

0°	2°	4°	6°	8°	10°	12°	14°	16°	18°	20°	22°	24°	26°	28°	30°	32°	34°	36°	38°
651	635	607	572	526	464	386	306	232	170	124	92	70	52	39	30	24	19	16	13
100%	98%	93%	88%	81%	71%	59%	47%	36%	26%	19%	14%	11%	8%	6%	5%	4%	3%	2%	2%

Beam Angle 50%	Field Angle 10%	Cut-off Angle 2.5%	Intensity Ratio in 120° Cone	Intensity Ratio in 90° Cone
27°	48.6°	70.2°	98.3%	95.7%

Glare Evaluation According to UGR

p Ceiling	70	70	50	50	30	70	70	50	50	30	
p Walls	50	30	50	30	30	50	30	50	30	30	
p Floor	20	20	20	20	20	20	20	20	20	20	
Room size X Y	Viewing direction at right angles to lamp axis					Viewing direction parallel to lamp axis					
2H	2H	21.2	21.9	21.4	22.1	22.3	21.3	22.0	21.6	22.2	22.4
	3H	21.9	22.5	22.2	22.7	23.0	22.0	22.6	22.2	22.8	23.1
	4H	22.1	22.7	22.4	22.9	23.2	22.2	22.8	22.5	23.0	23.3
	6H	22.2	22.7	22.5	23.0	23.3	22.3	22.9	22.6	23.1	23.4
	8H	22.2	22.7	22.5	23.0	23.3	22.3	22.9	22.7	23.1	23.4
12H	22.2	22.7	22.6	23.0	23.3	22.3	22.8	22.7	23.1	23.4	
4H	2H	21.5	22.1	21.8	22.3	22.6	21.6	22.2	21.9	22.4	22.7
	3H	22.3	22.8	22.6	23.1	23.4	22.4	22.9	22.7	23.2	23.5
	4H	22.6	23.0	22.9	23.3	23.7	22.7	23.1	23.0	23.4	23.8
	6H	22.8	23.1	23.2	23.5	23.9	22.9	23.2	23.3	23.6	24.0
	8H	22.8	23.1	23.2	23.5	23.9	22.9	23.3	23.3	23.6	24.0
12H	22.9	23.1	23.3	23.5	23.9	23.0	23.2	23.4	23.6	24.0	
8H	4H	22.7	23.0	23.1	23.4	23.8	22.8	23.1	23.2	23.5	23.9
	6H	22.9	23.2	23.4	23.6	24.0	23.0	23.3	23.5	23.7	24.1
	8H	23.0	23.2	23.5	23.6	24.1	23.1	23.3	23.6	23.8	24.2
	12H	23.1	23.2	23.5	23.7	24.2	23.2	23.3	23.6	23.8	24.3
12H	4H	22.6	22.9	23.1	23.3	23.7	22.8	23.0	23.2	23.4	23.8
	6H	22.9	23.1	23.4	23.6	24.0	23.0	23.2	23.5	23.7	24.1
	8H	23.0	23.2	23.5	23.6	24.1	23.1	23.3	23.6	23.7	24.2
Variation of the observer position for the luminaire distance S											
S = 1.0H	+1.5 / -1.0					+1.5 / -1.1					
S = 1.5H	+3.1 / -1.5					+3.2 / -1.4					
S = 2.0H	+4.7 / -1.7					+4.7 / -1.9					
Standard table	BK03					BK03					
Correction summand	5.2					5.3					
Corrected glare indices referring to 175lm total luminous flux											